



HERESY DESIGN[®]
CONVERSION KIT
MANUAL

TABLE OF CONTENTS:

Safety Warnings	2-4
State By State Warnings	5-6
Warranty Statement	7
Product Information	8-10
Installation	11
Exploded Views	12
Component Diagram	13
Component List	14



READ THE INSTRUCTIONS AND WARNINGS IN THIS MANUAL CAREFULLY BEFORE USING THIS PRODUCT; DO NOT DISCARD THIS MANUAL.

This operator's manual is designed to assist you in learning how to use and care for your Heresy Design Conversion Kit. Only when you are certain that you fully understand this manual and can properly carry out its instructions, should you practice loading and firing your firearm with live ammunition. Having a firearm in your possession is a full-time job; you cannot guess, and you cannot forget. You must know how to use your firearm safely. If you have any doubts about your ability to handle or use this firearm safely, you should seek supervised instruction.

SAFETY INFORMATION: The safety warnings in this manual are important. By understanding the dangers inherent in the use of any firearm, and by taking the precautions described herein, you can enjoy increased safety in the use of your rifle. Failure to heed any of these warnings may result in serious injury to you or others, as well as severe damage to the firearm or other property. Heresy Design shall not be responsible in any manner what-soever for malfunctioning of the firearm, physical injury, or property damage resulting in whole or in part from criminal or negligent discharge, improper or careless handling, unauthorized modifications, defective, improper, hand-loaded, or reloaded ammunition, corrosion, neglect, or other influences beyond our direct and immediate control.

BASIC RULES OF SAFETY:

When handling this, or any firearm, always follow the basic rules of gun safety.

- Treat every weapon as if it were loaded.
- Keep your finger straight and off the trigger until you intend to fire.
- Never point your weapon at anything you don't intend to shoot.
- Keep your weapon on safe until you intend to fire.

ADDITIONAL RULES FOR SAFETY:

- Know how to safely use the gun before shooting it. If unsure, consult a qualified expert.
- Before use, ensure the gun is in working condition. If unsure, consult a qualified expert.
- Clearly identify your target before firing and know what lies beyond your target before firing.
- Use proper eye and ear protection when shooting.
- Use only correct ammunition in your gun. If unsure, consult a qualified expert first.
- Never use guns while under the influence of alcohol or drugs.
- Always store guns properly to prevent access by unauthorized people.
- Firearms should be stored unloaded, in a secure location, separate from their ammunition.

LEAD EXPOSURE:

Discharging firearms in poorly ventilated areas, cleaning fire- arms, or handling ammunition may result in exposure to lead and other substances known to the state of California to cause birth defects, reproductive harm, and other serious physical injury. Maintain adequate ventilation at all times. Wash hands thoroughly after exposure.

SHOOTING OR CLEANING FIREARMS MAY EXPOSE YOU TO LEAD.

REGISTERED TRADEMARKS:

Steyr® and AUG® are the registered trademarks of the STEYR ARMS GMBH. All rights to these trademarks are owned by STEYR ARMS GMBH. In no way is Heresy Design Inc. endorsed or affiliated with STEYR ARMS GMBH.

WARNING: ALL NFA RULES APPLY

STATE-BY-STATE WARNINGS:

PLEASE CHECK WITH YOUR LICENSED RETAILER, STATE POLICE, OR LOCAL POLICE FOR ADDITIONAL WARNINGS, WHICH MAY BE REQUIRED BY LOCAL LAW OR REGULATION. SUCH REGULATIONS CHANGE CONSTANTLY, AND LOCAL AUTHORITIES ARE IN THE BEST POSITION TO ADVISE YOU ON SUCH LEGAL MATTERS.

CERTAIN STATES REQUIRE, BY LAW, THAT THEIR OWN SPECIFIED WARNING NOTICES, IN LARGER THAN-NORMAL TYPE BE CONSPICUOUSLY INCLUDED BY THE MANUFACTURER, DISTRIBUTOR, OR RETAIL DEALER WITH FIREARMS SOLD IN THAT STATE. BECAUSE OUR PRODUCTS MAY BE SOLD IN THESE STATES, WE INCLUDE THE FOLLOWING:

CA: Firearms must be handled responsibly and securely stored to prevent access by children and other unauthorized users. California has strict laws pertaining to firearms, and you may be fined or imprisoned if you fail to comply with them. Visit the web site of the California attorney general at <https://oag.ca.gov/firearms> for information on firearm laws applicable to you and how you can comply. Prevent child access by always keeping guns locked away and unloaded when not in use. If you keep a loaded firearm where a child obtains and improperly uses it, you may be fined or sent to prison." If you or someone you know is contemplating suicide, please call the national suicide prevention lifeline at 1-800-273 talk (8255).

CT: "Unlawful storage of a loaded firearm may result in imprisonment or fine."

FL: "It is unlawful, and punishable by imprisonment and fine, for any adult to store or leave a firearm in any place within the reach or easy access of a minor under 18 years of age or to knowingly sell or otherwise transfer ownership or possession of a firearm to a minor or a person of unsound mind."

ME: "Endangering the welfare of a child is a crime. If you leave a firearm and ammunition within easy access of a child, you may be subject to fine, imprisonment or both. Keep firearms and ammunition separate. Keep firearms and ammunition locked up. Use trigger locks."

MD: "Warning: children can operate firearms which may cause death or serious injury. It is a crime to store or leave a loaded firearm in any location where an individual knew or should have known that an unsupervised minor would gain access to the firearm. Store your firearm responsibly!"

MA: "Warning from the Massachusetts attorney general: this handgun is not equipped with a device that fully blocks use by unauthorized users. More than 200,000 firearms like this one are stolen from their owners every year in the United States. In addition, there are more than a thousand suicides each year by younger children and teenagers who get access to firearms. Hundreds more die from accidental discharge. It is likely that many more children sustain serious wounds or inflict such



wounds accidentally on others. In order to limit the chance of such misuse, it is imperative that you keep this weapon locked in a secure place and take other steps necessary to limit the possibility of theft or accident. Failure to take reasonable preventative steps may result in innocent lives being lost, and in some circumstances may result in your liability for these deaths." "It is unlawful to store or keep a firearm, pistol, shotgun or machine gun in any place unless that weapon is equipped with a tamper resistant safety device or is stored or kept in a securely locked container."

NJ: "It is a criminal offense to leave a loaded firearm within easy access of a minor."

NYC, NY: "The use of a locking device or safety lock is only one aspect of responsible firearms storage. For increased safety, firearms should be stored unloaded and locked in a location that is both separate from their ammunition and inaccessible to children and other unauthorized persons."

NC: Any person who resides in the same premises as a minor, owns or possesses a firearm, and stores or leaves the firearm (i) in a condition that the firearm can be discharged and (ii) in a manner that the person knew or should have known that an unsupervised minor would be able to gain access to the firearm, is guilty of a class 1 misdemeanor if a minor gains access to the firearm without the lawful permission of the minor's parents or a person having charge of the minor and the minor: 1. Possesses it in violation of G.S. 14-269.2(b), 2. Exhibits it in a public place in a careless, angry, or threatening manner; 3. Causes personal injury or death with it not in self-defense; or 4. Uses it in the commission of a crime.

TX: "It is unlawful to store, transport, or abandon an unsecured firearm in a place where children are likely to be and can obtain access to the firearm."

WI: "If you leave a loaded firearm within the reach or easy access of a child you may be fined or imprisoned or both if the child improperly discharges, possesses, or exhibits the firearm."

Please check with your licensed retailer, state police, or local police for additional warnings, which may be required by local law or regulation. Such regulations change constantly, and local authorities are in the best position to advise you on such legal matters.

WARRANTY STATEMENT:

Heresy Design Inc. warrants that the enclosed product was originally manufactured free of defects in material, workmanship, and mechanical function. For the lifetime of the product, Heresy Design Inc. agrees to correct any manufacturer defects via repair, adjustment, or replacement with the same or comparable quality components.

This limited warranty is null and void if the product has been misused, damaged, fired with hand-loaded, reloaded, or improper ammunition, fired with an obstruction in the barrel, or if unauthorized alteration/repair has been performed.

Our company policy is to do the right thing. If you have a problem, we want to hear about it, and we want to make it right. That's our commitment to you as our customer.

CONTACT INFORMATION:

If you have any questions, concerns, or need additional information, please visit our website at www.HeresyDesign.com, or contact our team:



sales@heresydesign.com | 208-998-0192
111 7th St., #2516, Coeur d'Alene ID 83816

PRODUCT INFORMATION:

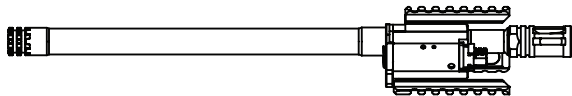

HB14A

14.5" Barrel
5.56 NATO

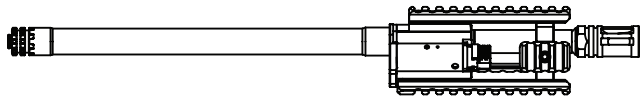

HB16A

16.3" Barrel
5.56 NATO

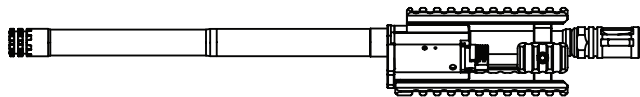

HB16B

16.3" Barrel
.300BLK

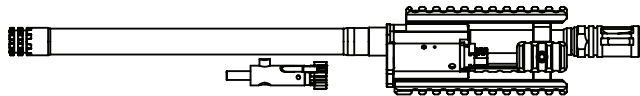

HBA16C

16.3" Barrel
7.62x39

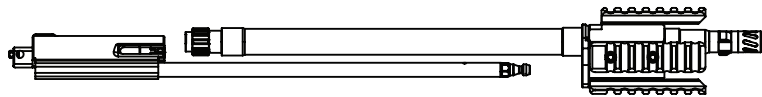

HBA16D

16.1" Barrel
9MM



GAS ADJUSTMENT SYSTEM:

To adjust the gas settings, apply downward pressure on the top edge of the knob towards the bottom. While doing so, you will hear a distinct click sound, indicating the detent has disengaged.

Twist the gas adjustment knob in a clockwise direction until you hear the detent engage on the next setting.

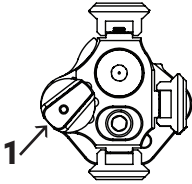
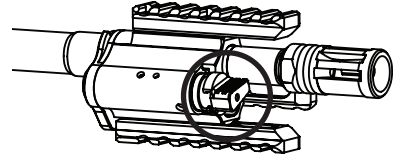

Setting 1 allows the most gas to flow through. This setting is recommended for unsuppressed shooting with standard ammunition.

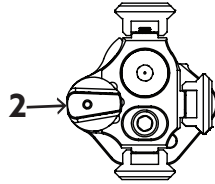

Setting 2 restricts the gas flow for heavier military ammunition and low back pressure suppressors.

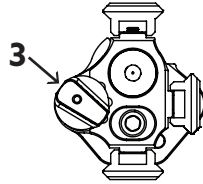

Setting 3 restricts the most gas and is recommended for high back pressure suppressors.

HB14A
14.5" BARREL
5.56

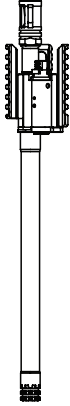

BARREL CHANGE

HB16A
16.3" BARREL
5.56

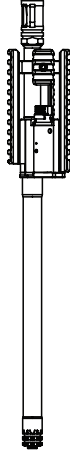

BARREL CHANGE

HB16B
16.3" BARREL
.300BLK

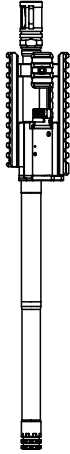

BARREL CHANGE

HBA16C
16.3" BARREL
7.62x39



**BARREL & BOLT
CHANGE**

HBA16D
16.1" BARREL
9MM



**BARREL, BOLT GROUP &
MAGAZINE CHANGE**



HOW TO INSTALL HERESY DESIGN® PARTS ON YOUR STEYR® AUG®:

Before starting, refer to the manufacturer's manual provided with your Steyr® AUG®.

1. Follow the instructions in your Steyr® AUG® manual to safely remove the barrel group. If your Heresy Design® kit requires only a barrel change, please proceed to step 4.
2. If your Heresy Design® kit requires changing the bolt group or assembly within the bolt group, follow the Steyr® AUG® manual to remove the receiver group and bolt group.
3. Replace the factory barrel, bolt group, or bolt with the Heresy Design® parts as indicated on page 11.
4. Re-install the Heresy Design® assemblies (barrel group or barrel group, bolt group, and receiver group) into your Steyr® AUG® according to the manual.
5. Always double-check that you are using the correct Heresy Design® parts and that you are not mixing non-compatible parts.
6. Before loading, perform a thorough function check as outlined in the manual.



11

WARNING: BE AWARE OF WHERE YOUR MUZZLE IS POINTED AT ALL TIMES. NEVER REACH YOUR ARM ACROSS THE MUZZLE WHEN CHANGING THE BARREL GROUP.

**EXPLODED VIEW HB16B
(.300BLK CONVERSION KIT)**

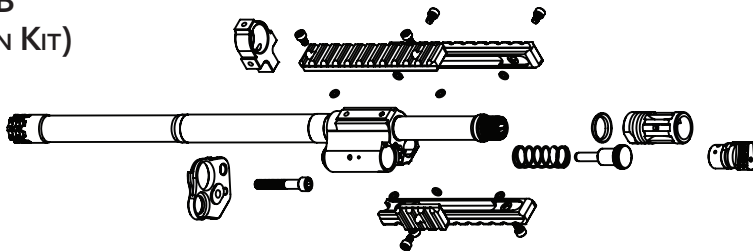

**EXPLODED VIEW HBA16D
(9MM CONVERSION KIT)**

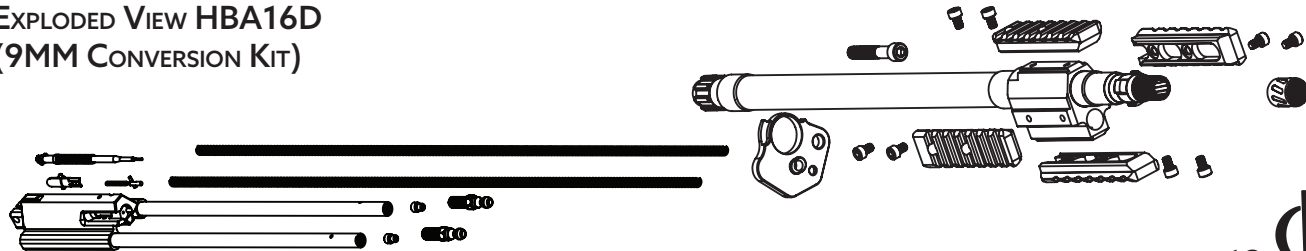

COMPONENT LIST:

ITEM	DESCRIPTION
1	Barrel Sub Assembly
2	Rail Support Bracket
3	Crush Washer
4	Flash Hider
5	Gas Block Timing Plate
6	Gas Block Timing Plate Screw
7	Gas Adjustment Spring
8	Gas Ring
9	Piston
10	Gas Adjustment Knob

ITEM	DESCRIPTION
A	Long Side/Bottom Rail
B	Long Top Rail
C	Short Side Rail
D	Short Top Rail
E	GAK Side Rail

SKU	RAILS INCLUDED
HB14A	1, 3, 4, 5
HB16A	1, 1, 2, 5
HB16B	1, 1, 2, 5
HBA16C	1, 1, 2, 5
HBA16D	1, 3, 4, 5



13

Please note some parts vary by model

COMPONENT DIAGRAM:

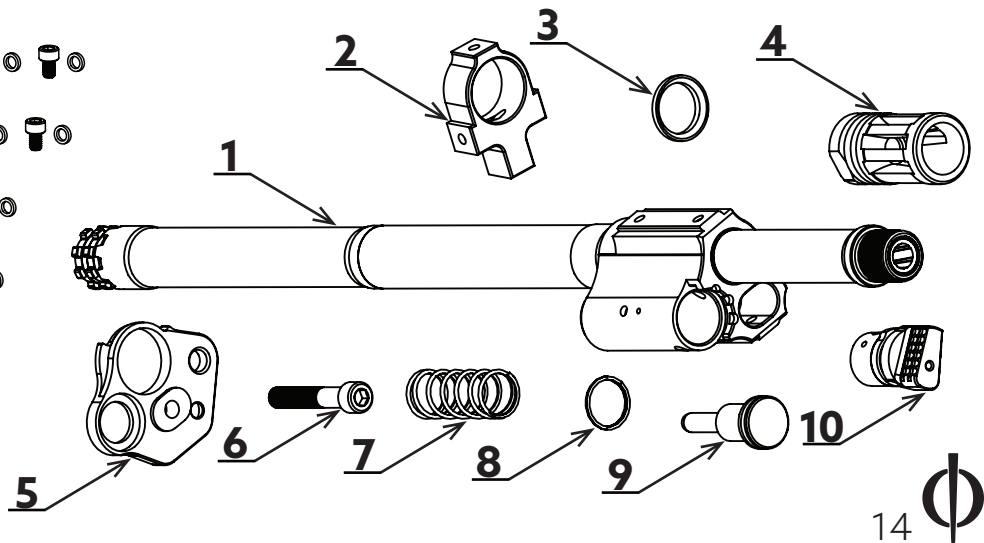

Manual Rev.
J-23



For More Information, Please Visit HeresyDesign.com